

Technische automatisering

Opgave: Waarheidstabellen

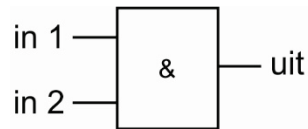

in 1	in 2	uit
1	1	1
0	1	0
1	0	0
0	0	0

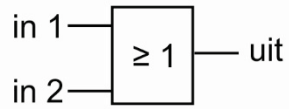

in 1	in 2	uit
1	1	1
0	1	1
1	0	1
0	0	0

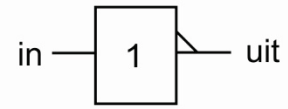

in	uit
1	0
0	1

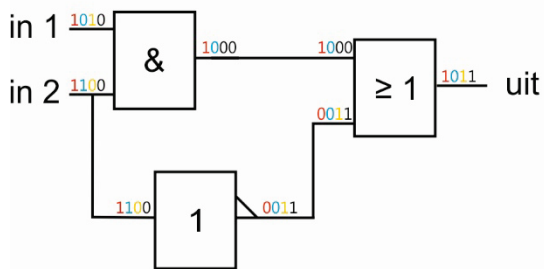

in 1	in 2	uit
1	1	1
0	1	0
1	0	1
0	0	1

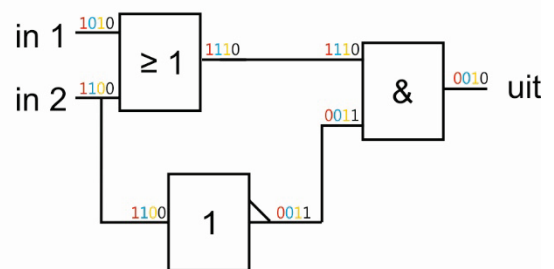

in 1	in 2	uit
1	1	0
0	1	0
1	0	1
0	0	0

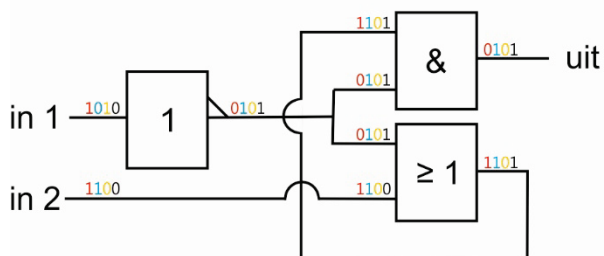

in 1	in 2	uit1
1	1	0
0	1	1
1	0	0
0	0	1

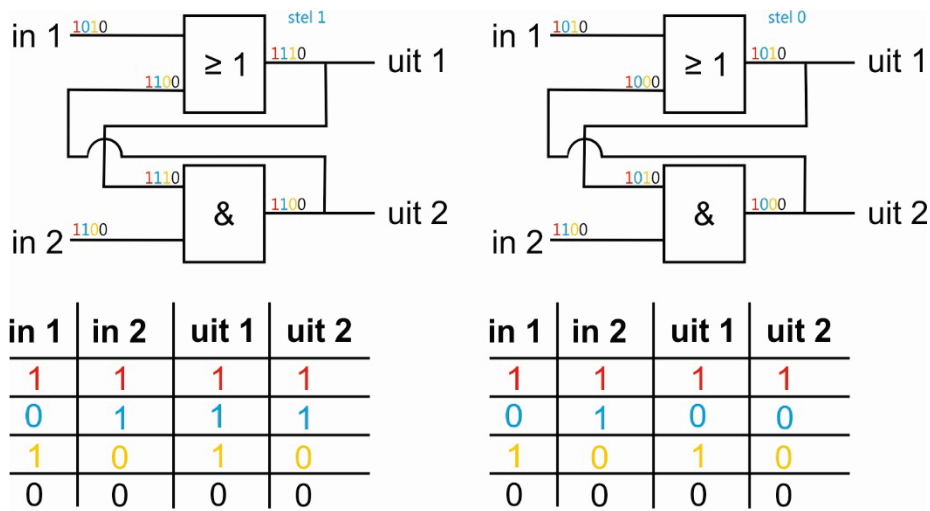

Er is geen eenduidige waarheidstabel mogelijk.
 Afhankelijk van de begintoestand zijn er 2 mogelijkheden.